

## Fuzzy MPPT for PV System Based on Custom Defuzzification

Abdelmadjid Allaoui\*, Mohamed Nacer Tandjoui, Chellali Benachaiba

Electrical Engineering Department, Faculty of Science and Technology, Tahri Mohamed University, Bechar, 08000, Algeria

### ARTICLE INFO

Article history:

Received: 20 January, 2023

Accepted: 07 May, 2023

Online: 25 July, 2023

Keywords:

PV system

Fuzzy MPPT

Defuzzification

### ABSTRACT

Due to the variations in weather conditions, photovoltaic systems adopt a technique based on maximum power point tracking to extract the maximal power of the solar module. In the literature, there are many different methods classical and intelligent of maximum power point tracking (MPPT). But, due to the semiconductor effect, the current-voltage characteristics of the solar module is nonlinear. This affects its efficiency and make its control not easy. In this contribution, we present a new fuzzy PV MPPT based on custom defuzzification. The obtained power using the proposed fuzzy PV MPPT based on custom defuzzification is significant compared to Pertub & observe and fuzzy PV MPPT in term of performances indices such as: Rise time and overshoot.

## 1. Introduction

Generally, energy is an important development factor in any economy. Also, energy consumption is a progress indicator. The energy crisis due to the drop of conventional energy sources and the rise in CO<sub>2</sub> emission and environmental pollution has imposed the search for other solutions which are renewables and cleans. As renewable source, photovoltaic power is a very powerful and promising energy potential. The solar energy is converted into electrical energy by solar PV panel. Each type of PV panel has its own specific characteristic according to local conditions such as irradiation, and temperature and this makes the tracking of maximum power point (MPP) a complicated problem. To remedy this problem, many MPPTs algorithms have been presented [1-6]. Conventional MPPTs have proven to be less efficient because of the functioning principle of photovoltaic system which depends on weather.

This, made extracting the maximum power point a difficult task. But, with the development of semiconductor switches which work with high switching frequencies; new MPPT controllers have been developed. Among the intelligent MPPTs, there is the logic-based MPPT which has interested several researchers. In the literature, there are several publications on this fuzzy MPPT controller with more approaches [7-13]. In this context, we will present an intelligent MPPT based on fuzzy logic but which is different with a custom defuzzification function because most of the papers dedicated to this field use default and predefined defuzzification functions.

## 2. Modeling of photovoltaic system

Photovoltaic system works on the photovoltaic effect to convert solar radiation into direct current. When the sun attacks the panel, the energy is absorbed by a semiconductor. This energy will release the electron-hole pairs from their binding state to supply the load of the photovoltaic system. The output power of the photovoltaic panel depends on environmental variables such as irradiation and temperature. Therefore, to operate the PV system at its maximum power point; the MPPT mechanism is very important and useful. Many MPPT mechanisms have been introduced in the literature by many researchers since the year 1960. Some well-known conventional MPPT methods are incremental conductance, perturbation and observation and constant voltage.

However, this type of method presents classical and limited algorithms. Their implementation requires a good, accurate sensor to measure either voltage or current. Recently, the MPPT based on artificial intelligence is widely used in PV system. These intelligent MPPTs are dynamic with high efficiency and have made the PV system interesting and competitive. Figure 1 shows the block diagram of the proposed standalone PV system. The system consists of a PV array, a MPPT controller combined to a DC-DC converter and a load.

The irradiation ( $G$ ) and temperature ( $T$ ) are in charge of the working point of PV system at the maximum power point (MPP) [14]. The cell current,  $I$ , which represents the mathematical model of the PV cell can be express as:

\*Corresponding Author Abdelmadjid Allaoui,  
allaoui.abdelmadjid1978@gmail.com

$$I = I_{ph} - I_0 \left( e^{\left( \frac{q(V+IR_s)}{A.K_c.T} \right)} - 1 \right) \frac{V + IR_s}{R_{sh}} \quad (1)$$

where,  $I_{ph}$  is light-generated cell current (A),  $I_0$  is cell reverse saturation current (A),  $q$  is electronic charge,  $A$  is ideality factor,  $K_c$  is Boltzmann's constant, and  $T$  is cell temperature (K).

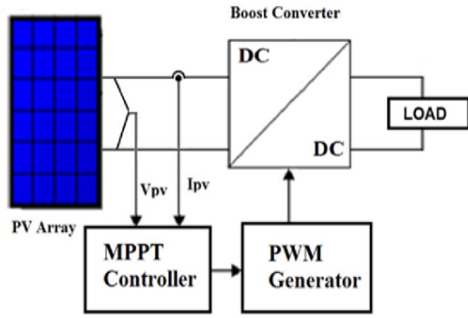

Figure 1: Block diagram of the PV system

### 3. Perturb & Observe MPPT

Perturb & Observe algorithm is a conventional method. It is used in photovoltaic systems because of its simple implementation. Also, it needs a few measured parameters. It is based on the measure of the PV current and voltage. From these values the power is calculated at each time to find out the maximum power point (MPP).

The principle of this algorithm is based on the operating voltage of the PV module which is perturbed by a small increment and the change of power is observed. If the change of power is positive, then it is supposed that it has moved the operating point closer to the MPP. So, the voltage disturbed in the same track should move the operating point toward the MPP. If the change of power is negative, the operating point has moved away from the MPP. In this case, the direction of perturbation should be reversed.

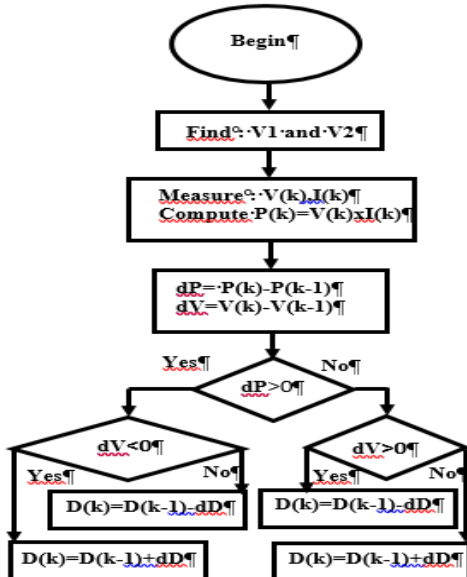

Figure 2: Flowchart of P&O method

### 4. Fuzzy MPPT based custom defuzzification

The MPPT allows the PV system to work at the maximum despite the variation of its parameters, irradiation, temperature and load. Conventional MPPT methods are limited, however, MPPT based on fuzzy logic offers the advantage of being robust, efficient and works to the PPM. The implement of the fuzzy MPPT has three steps: the fuzzification, inference engine and defuzzification (Figure 3).

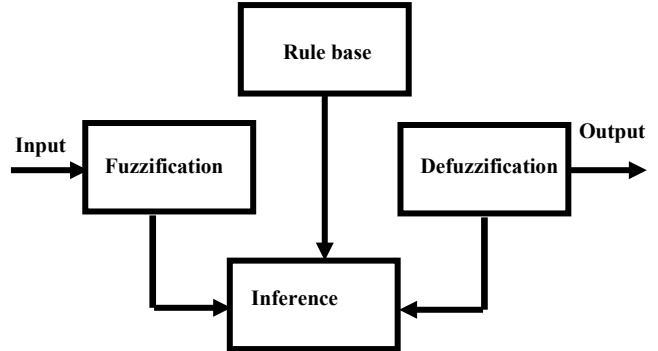

Figure 3: Fuzzy MPPT block diagram

#### 4.1 Fuzzification method

Fuzzification is a method by which sharp values are blurred. To do this, the linguistic variables and the membership functions that will be implemented to model the system must be defined. The principle of fuzzification consists in the decomposition of the universe of discourse of linguistic input and output variables into a number of membership functions.

#### 4.2 Inference engine

Inference is a method by which new information is deduced from the information of premises. Inference in fuzzy logic control systems is a method by which the result of each rule is deduced from the results of each activated rule.

In the literature, dedicated to fuzzy logic, different methods that can be applied to establish an inference engine. The most popular are Mamdani and Takagi-Sugeno-Kang. The Mamdani inference was developed by Ebrahim H. Mamdani in 1975. It was used to modify the behavior of a steam engine. Mamdani's inference was inspired from Lofti Zadeh's paper describing fuzzy sets for systems. For Mamdani max-min inference, the minimal operation is used at implication stage, while the max-min operator is employed to the premises.

#### 4.3 Defuzzification

$$z_{COA} = \frac{\int z \mu_A(z) dz}{\int \mu_A(z) dz} \quad (2)$$

where,  $z_{COA}$  is the control output.

The fuzzy MPPT has two inputs: error (err) and the variation of the error (derr) which are defined by the equations (3) and (4).

$$err = \frac{P_{pv}(k) - P_{pv}(k-1)}{V_{pv}(k) - V_{pv}(k-1)} \quad (3)$$

$$derr(k) = err(k) - err(k-1) \quad (4)$$

where,  $P_{pv}(k)$  and  $V_{pv}(k)$  are respectively the output power and instantaneous voltage of the photovoltaic source.

The inference rules are used to evaluate the linguistic values of the activated rules according to their membership degrees. For Mamdani inference, the inference of each activated rule gives a surface. The aggregation of these surfaces gives a final surface which by the defuzzification generates the value of the modulator. The defuzzification allows the conversion of membership degree in crisp value.

Each linguistic variables of the input and the output of the proposed fuzzy MPPT based on custom defuzzification has five membership functions. The used linguistic values are: NB (Negative Big), NS (Negative Small), ZE (Zero), PS (Positive Small) and PB (Positive Big).

The majority of researchs uses Matlab's predefined defuzzification functions for fuzzy MPPT controller. Through this contribution, we will propose a custom function of defuzzification which will boost the action of the fuzzy MPPT controller.

$$Z_{Custom} = \frac{\sum_{i=0}^n k ymf_i x_i}{\sum_{i=0}^n ymf_i^2} \quad (4)$$

where, k is a gain that regulates the rise time.

### 5. Simulation and discussion

The proposed fuzzy PV MPPT based on custom defuzzification is compared to P&O MPPT. The simulation system is presented below.

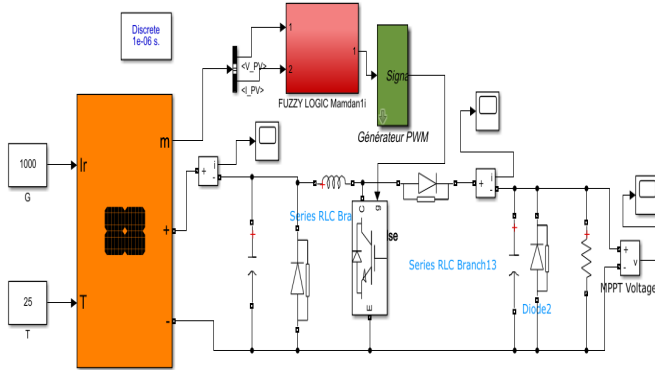

Figure 4: Simulation system under Matlab Simulink

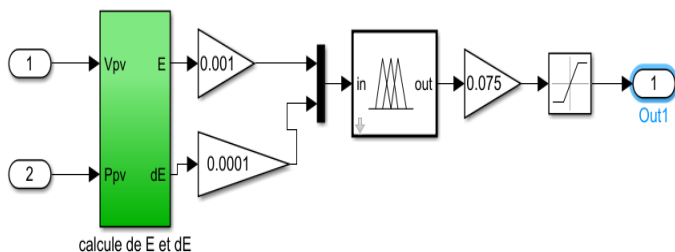

Figure 5: Fuzzy MPPT controller design

Figure 5 shows the design of fuzzy PV MPPT controller which has two inputs: Error and change of error according to “(2)” and “(3)”. Table 1 presents the electrical characteristic values of the PV module.

Table 1: Electrical characteristics of the PV module

Electrical characteristics	values
Maximum power (W)	85.383
Cells per module (Ncell)	36
Open circuit voltage Voc (V)	22
Short circuit current Isc (A)	5.2
Voltage at maximum power point Vmp (V)	17.9
Current at maximum power point Imp (A)	4.77

Figures 6-9 show simulation steps of fuzzy controller for PV MPPT with custom defuzzification function. The inputs to the fuzzy controller are error and error variation of the PV system. The error is the ratio between the variation of the power on the variation of the PV voltage. The output of the fuzzy controller represents the modulator which will modulate the carrier of the PWM generator to produce the PWM signal which will drive the switch of the boost converter according to the inferences of fuzzy controller for PV MPPT.

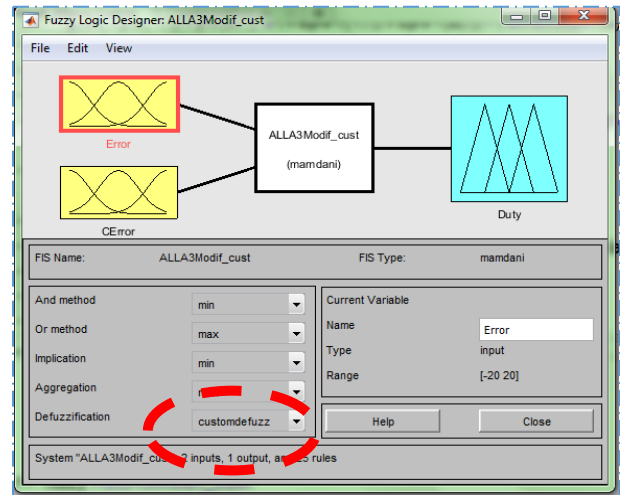

Figure 6: Fuzzy logic designer

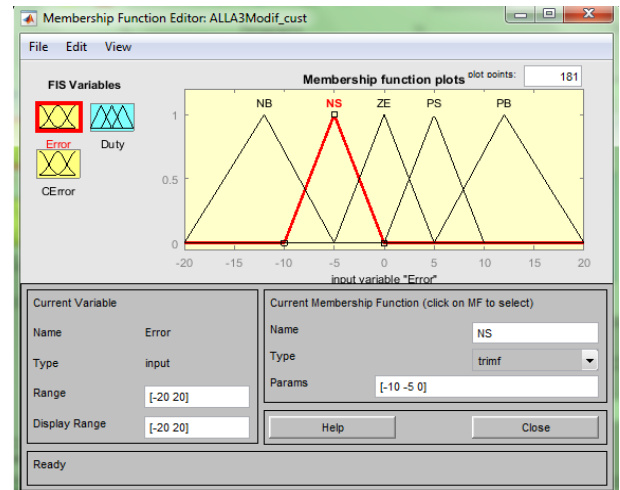

Figure 7: Error membership functions

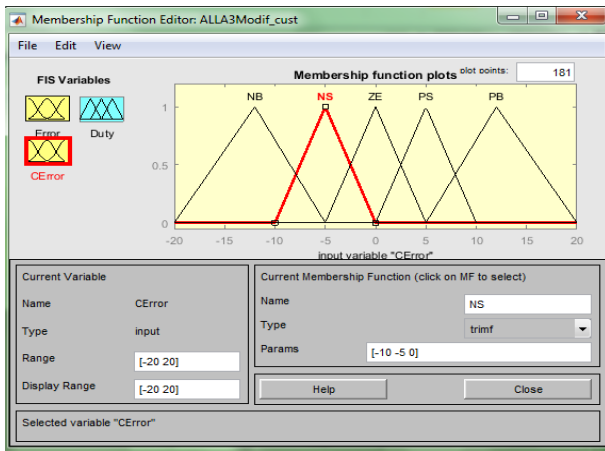

Figure 8: Change of error membership functions

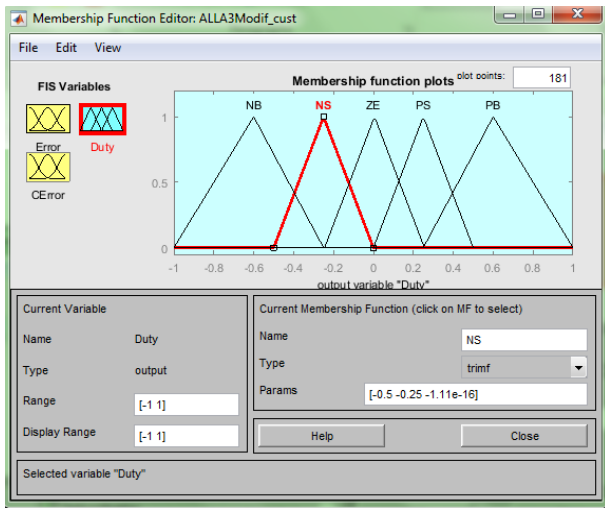

Figure 9: Output membership functions

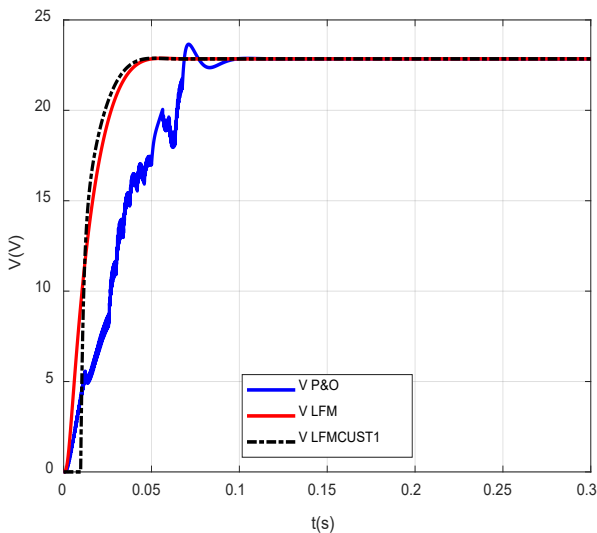

Figure 10: Load voltages

Figures 10-15 present the results obtained from the simulated system which are the voltage, the current and the power of the load. Each figure presents the comparison of the three PV MPPTs which are P&O, fuzzy with Mamdani inference and centroid defuzzification and the response of the proposed fuzzy PV MPPT

with Mamdani inference and custom defuzzification. The contribution of fuzzy PV MPPT is interesting. The response of the proposed fuzzy PV MPPT with Mamdani inference and custom defuzzification is better than the other MPPTs. Table 2 shows the load power performance of the three MPPTs, and the response of the proposed fuzzy MPPT for PV system with Mamdani inference and custom defuzzification presents less rise time and overshoot than other MPPTs.

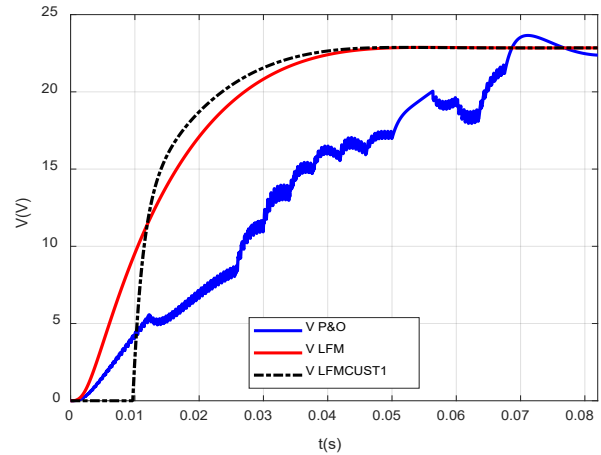

Figure 11: Zoom of load voltages

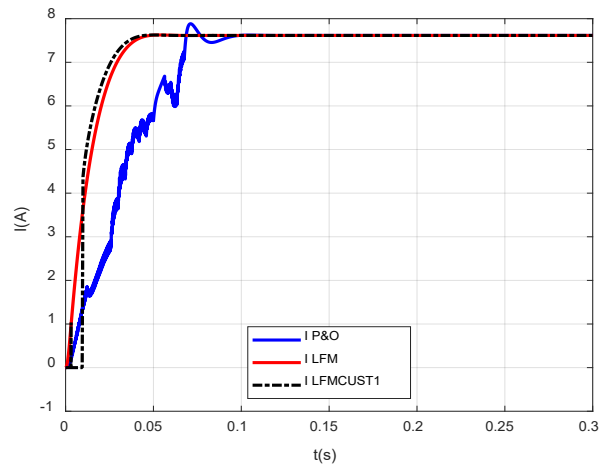

Figure 12: Load currents

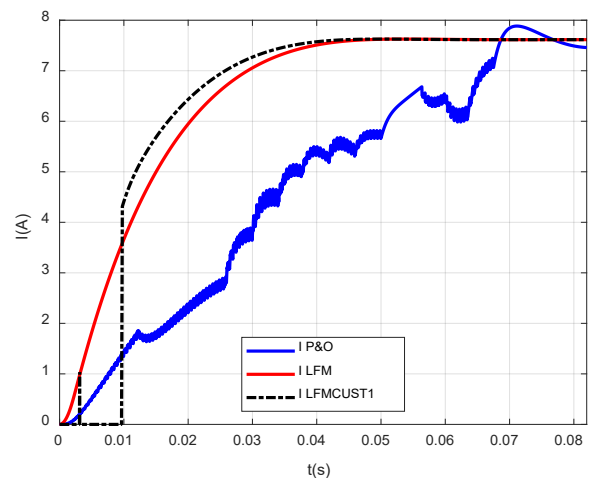

Figure 13: Zoom of load currents

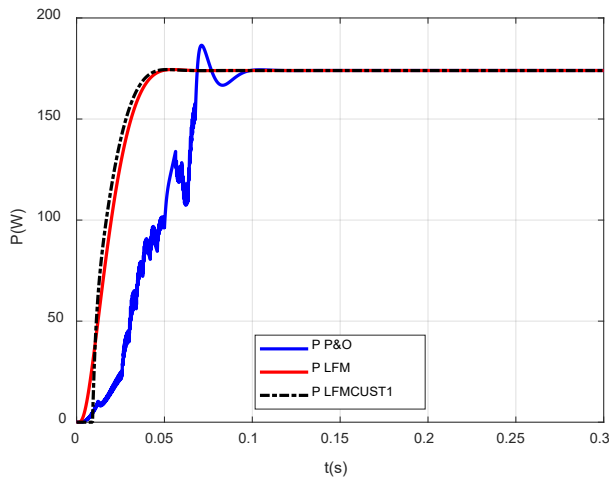

Figure 14: Load powers

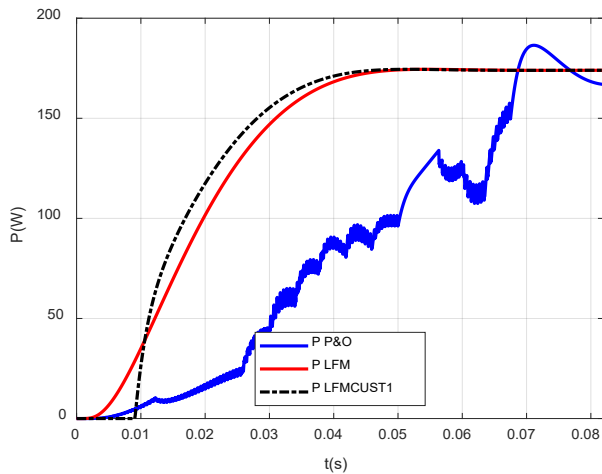

Figure 15: Zoom of load powers

Table 2: Performance of load power responses

Performance indices	P&O	Fuzzy MPPT with Centroid defuzz.	Fuzzy MPPT with Custom defuzz.
RiseTime	0.0470	0.0262	0.0209
SettlingTime	0.0902	0.0422	0.0393
SettlingMin	149.7038	156.5957	156.5957
SettlingMax	186.4765	174.4732	174.4730
Overshoot	7.1669	0.2762	0.2760
Peak	186.4765	174.4732	174.4730
PeakTime	0.0712	0.0545	0.0516

**6. Conclusion**

Conventional MPPTs have proven to be less efficient because of the functioning principle of photovoltaic system which depends

on weather conditions. The principle of fuzzy logic based on the degree of membership has made it possible to implement a more efficient and more robust MPPT controller than conventional ones.

In order to make the MPPT controller faster and at the same time enrich the literature in this domain, we have proposed a new fuzzy PV MPPT controller based on custom defuzzification function. The results obtained show the action of defuzzification is important in the system response.

The proposed fuzzy PV MPPT controller based on custom defuzzification has confirmed this action and has given better results than both MPPT controllers P&O and Fuzzy MPPT for PV system according to of the performance indices of the responses.

**References**

- [1] J. M. Riquelme-Dominguez, S. Martinez, "Systematic Evaluation of Photovoltaic MPPT Algorithms Using State-Space Models Under Different Dynamic Test Procedures," IEEE POWER & ENERGY SOCIETY SECTION, **10**, 45772–45783, 2022, doi: 10.1109/ACCESS.2022.3170714.
- [2] X. Li, Q. Wang, H. Wen, and W. Xiao, "Comprehensive studies on operational principles for maximum power point tracking in photovoltaic systems," IEEE Access, **7**, 121407–121420, 2019, doi: 10.1109/ACCESS.2019.2937100.
- [3] R. Dutta, R. P. Gupta, "Performance analysis of MPPT based PV system: A case study," 2nd International Conference on Emerging Frontiers in Electrical and Electronic Technologies, Patna, India, doi: 10.1109/ICEFEET51821.2022.9847729.
- [4] M. Etezadinejad, B. Asaei, S. Farhangi, A. Anvari-Moghaddam, "An Improved and Fast MPPT Algorithm for PV Systems Under Partially Shaded Conditions," IEEE Transactions on Sustainable Energy, **13**(2), 732–742, 2022, doi:10.1109/TSTE.2021.3130827.
- [5] X. Li, H. Wen, Y. Hu, L. Jiang, "A novel beta parameter based fuzzy-logic controller for photovoltaic MPPT application", Renewable Energy, **130**, 416-427, 2019, doi:10.1016/j.renene.2018.06.071.
- [6] J. S. Ko, J. H. Huh, J. C. Kim, "Overview of maximum power point tracking methods for PV system in micro grid," Electronics, **9**(5), 816, 1–22, 2020, doi.org/10.3390/electronics9050816.
- [7] R.B. Bollipo, S. Mikkili, P. K. Bonthagorla, "Hybrid, optimal, intelligent and classical PV MPPT techniques: a review," CSEE Journal of Power and Energy Systems, **7**(1), 9–33, 2021, doi: 10.17775/CSEEJPES.2019.02720.
- [8] Tao Hai, Jincheng Zhoua, Kengo Muranak, "An efficient fuzzy-logic based MPPT controller for grid-connected PV systems by farmland fertility optimization algorithm," Optik, **267**, 2022, doi.org/10.1016/j.ijleo.2022.169636
- [9] P. Boonraksa, T. Chaisa-Ard, S. Sommat, P. Pimpru, T. Boonraksa, B. Marungsri, "Design and Simulation of Fuzzy logic controller based MPPT of PV module using Matlab Simulink," International Electrical Engineering Congress, 2022, doi: 10.1109/iEECON53204.2022.9741641.
- [10] F. Mehazzem, M. André, R. Calif, "Efficient Output Photovoltaic Power Prediction Based on MPPT Fuzzy Logic Technique and Solar Spatio-Temporal Forecasting Approach in a Tropical Insular Region," Energies, **15**, 1–21, 2022, doi.org/10.3390/en15228671.
- [11] C. R. Algarín, J. T. Giraldo, O. R. Álvarez, "Fuzzy Logic Based MPPT Controller for a PV System," Energies, **10**(12), 2–18, 2017, doi: 10.3390/en10122036.
- [12] G.F.T. Kebir, C. Larbes, A. Ilincia, T. Obeidi, S. T. Kebir, "Study of the Intelligent Behavior of a Maximum Photovoltaic Energy Tracking Fuzzy Controller," Energies, **11**, 2–20, 2018, doi: 10.3390/en1123263.
- [13] Tehzeeb-ul Hassan, R. Abbassi, H. Jerbi, K. Mehmood, M.F. Tahir, K. M. Cheema, R. M. Elavarasan, F. Ali, I. A. Khan, "A Novel Algorithm for MPPT of an Isolated PV System Using Push Pull Converter with Fuzzy Logic Controller," Energies, **13**, 2–21, 2020, doi: 10.3390/en13154007.
- [14] M. Seyedmahmoudian, R. Rahmani, S. Mekhilef, A.M.T. Oo, A. Stojcevski, T. K. Soon, A. S. Ghandhari, "Simulation and Hardware Implementation of New Maximum Power Point Tracking Technique for Partially Shaded PV System Using Hybrid DEPSO Method," IEEE Trans. Sustain. Energy, **6**(3), 850–862, 2015, doi:10.1109/TSTE.2015.2413359.